

POWERFLEX®

PART NUMBER

PFR3-216

DESCRIPTION

REAR UPPER ARM INNER BUSH

INSTALLATION GUIDE

Contents (parts per pack):

2 x Polyurethane Bushes 1 x PTFE/Silicone Grease
2 x Large Mild Steel Washers 2 x Stainless Steel Sleeves
2 x Small Mild Steel Washers

Please read the complete fitting instructions and check package components before fitment. These fitting instructions are to be used as a guide and in conjunction with workshop manual.

It is recommended that:

- all work to be carried out by a licensed technician;
- all safety precautions adhered to;
- wheel alignment to be checked and adjusted as required after any suspension work.
- All fasteners must be tensioned to manufacturer's torque settings.



Fitting Instructions:

1. Remove the rear upper cast arm from the car and remove both the original bushes including the outer shells.
2. Clean the bores of the arm removing any dirt or corrosion.
3. The bushes fit with the lip of the bush facing towards the centre of the arm (see fig 2).
4. Grease the bores of the bushes and both end faces. Push the stainless steel sleeves into the bushes.
5. Fit the arm back onto the car, fit the larger washers between the larger diameter of the bush and the tube of the car. Place one of the smaller washers on the bolt, fit the bolt then place the other small washer on the bolt before replacing the nut.
6. Refit the arm and tension all hardware to manufacturers recommended torque settings.



Figure 1 - Fitted Image

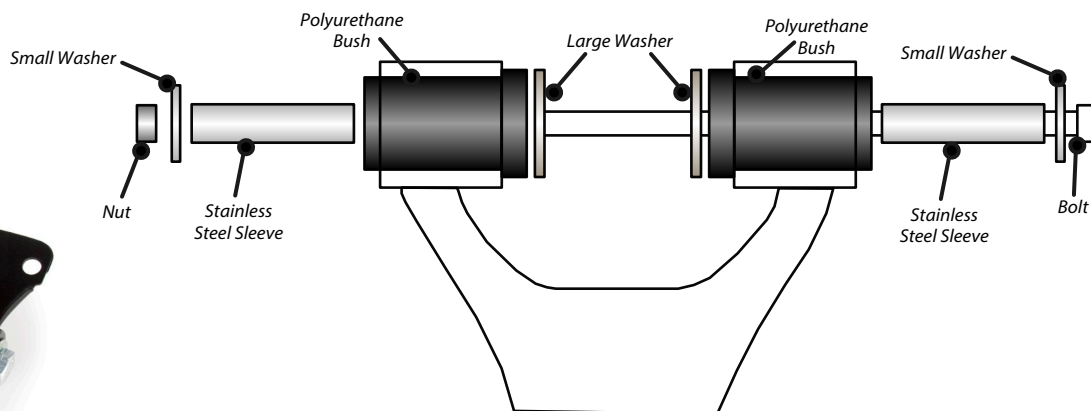

Figure 2